

Para montar o módulo suspenso, fixe-o na parede com as buchas (E) e parafusos (L).
Para montar el móvil suspendido fijar en la pared con los accesorios (E y L).

To mount the suspend mode, fix it on the wall with the wall plugs (E) and screws (L).

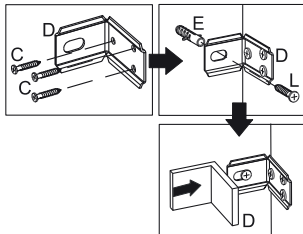

Fixação da bucha/Fijación Casquillo/Fixing os the plug

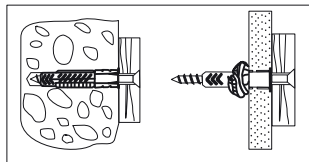

BS33

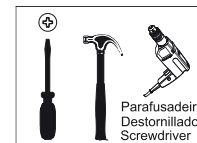

Ferramentas necessárias
(não fornecidas)
Herramientas necesarias
(no se incluye con el producto)
Needed tools
(not included)

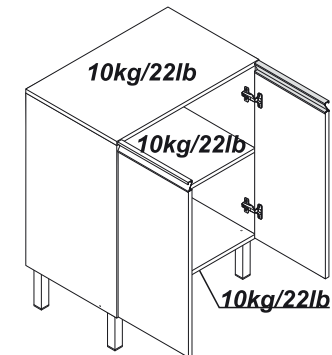
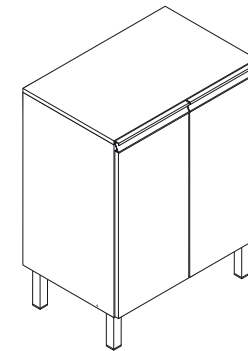

Peso Máximo suportado pelo produto
Peso Máximo suportado por el producto
Product weight limit



Atenção!

Parabéns, você está adquirindo um produto com a qualidade BRV Móveis.

- Antes de iniciar a montagem leia e observe severamente este manual.
- IMPORTANT!** Para que o produto não perca a garantia, solicitemos observar atentamente as orientações de montagem como: fixação do produto na parede, colocação de cola em locais específicos necessários, o peso suportado pelo produto, etc...
- Caso não sinta segurança em realizar a montagem deste produto, contrate um profissional capacitado.
- Aconselhamos utilizar embalagem para forrar o chão, afim de não danificar o produto.
- Este produto deve ser fixado na parede, afim de evitar acidente com crianças.

Limpeza:

- Pano levemente umedecido com água, seguido de pano seco.
- Não utilizar produtos químicos ou abrasivos.
- Utilizar pano com álcool **SOMENTE** para eliminar a numeração de identificação da peça.

Atención!

- Felicitaciones, usted está recibiendo un producto de calidad BRV Muebles.
- Antes de comenzar el montaje, lea estas instrucciones cuidadosamente.
- IMPORTANT!** Para que el producto no pierda la garantía, pedimos que lea atentamente las instrucciones, principalmente la fijación del producto en una pared, colocación de cola en local específico y necesario, el peso soportado por el producto etc...
- Si usted no se siente seguro en hacer el montaje de este producto, póngase en contacto con un profesional.
- Se recomienda el uso de la caja del producto para cubrir el piso, a fin de no dañar el producto.
- Es necesario colgar el producto en la pared para evitar accidentes entre los niños.

Limpeza:









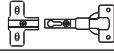
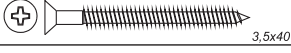

- Solamente usar un paño húmedo y jabón neutro.
- No utilice productos químicos o abrasivos.
- Utilice un paño con alcohol **SOLAMENTE** para sacar los números de identificación de las piezas.

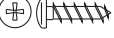
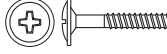
Attention!

- Congratulations, you're acquiring a product with BRV Móveis quality.
- Before starting to assemble the product, read and observe carefully this manual.
- IMPORTANT!** In order to keep the guarantee of the product we request to carefully observe the guidances like: fixing the product on the wall, adding glue in needed and specified places, product weight limit, etc.
- In case you don't feel confident to assemble this product, contact a professional to do the job.
- We advise to use the package to protect the floor in order to prevent damages.
- This product needs to be fixed on the wall in order to avoid children accident.

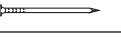
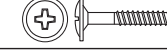
Cleanig:

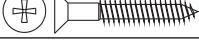
- Slightly dampened cloth and after a dry cloth.
- Do not use chemicals or abrasives.
- Alcohol can be used **ONLY** to delete the identification numbers of the pieces.

Ferragens/Herrajes/Ironmongery (mm)	QTD.	Ferragens/Herrajes/Ironmongery (mm)	QTD.
A  8x30	12	J 	04
B  3,5x40	02	K  Perfil Puxador	02
C  3,5x14	10	L  5,0x50	02
D 	02	M 	04
E  8 mm	02	N 	04
F  10x10	25	P  Pé plástico	04
G  3,5x12	16	Q 	02
H  4,5x25	02	R 	01

COD	Descrição/Descripción/Description	QTD.	mm	in
1- 3898	Lateral Direita/Lateral Derecha/Right Side	01	380x625x15	15x24.6x0.59
2- 3899	Lateral Esquerda/Lateral Izquierda/Left Side	01	380x625x15	15x24.6x0.59
3- 3900	Tampo/Tapa/Top	01	380x594x15	15x23.4x0.59
4- 3902	Prateleira/Estante/Shelf	01	380x564x15	15x22.2x0.59
5- 0000	Costa/Revés/Back	02	315x580x2,5	12.4x22.8x0.09
6- 3903	Porta/Puerta/Door	02	294x600x15	11.6x23.6x0.59
7- 3901	Base/Base/Base	01	380x564x15	15x22.2x0.59

**PRÉ-MONTAGEM
FASE DE PREPARACIÓN
DE LAS PIEZAS
PRE-ASSEMBLING**

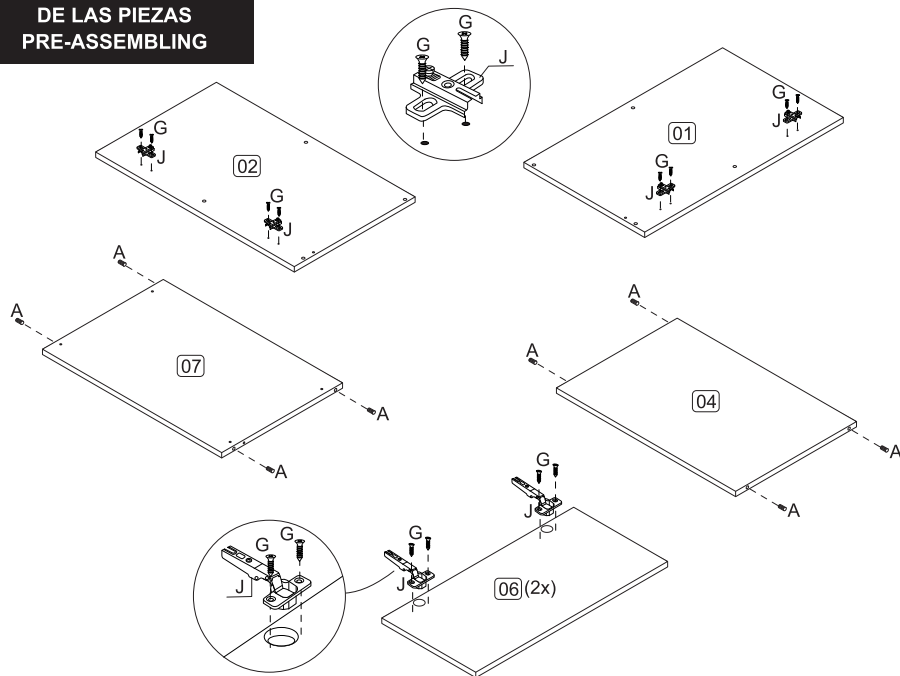

**MONTAGEM
MONTAJE
ASSEMBLING**

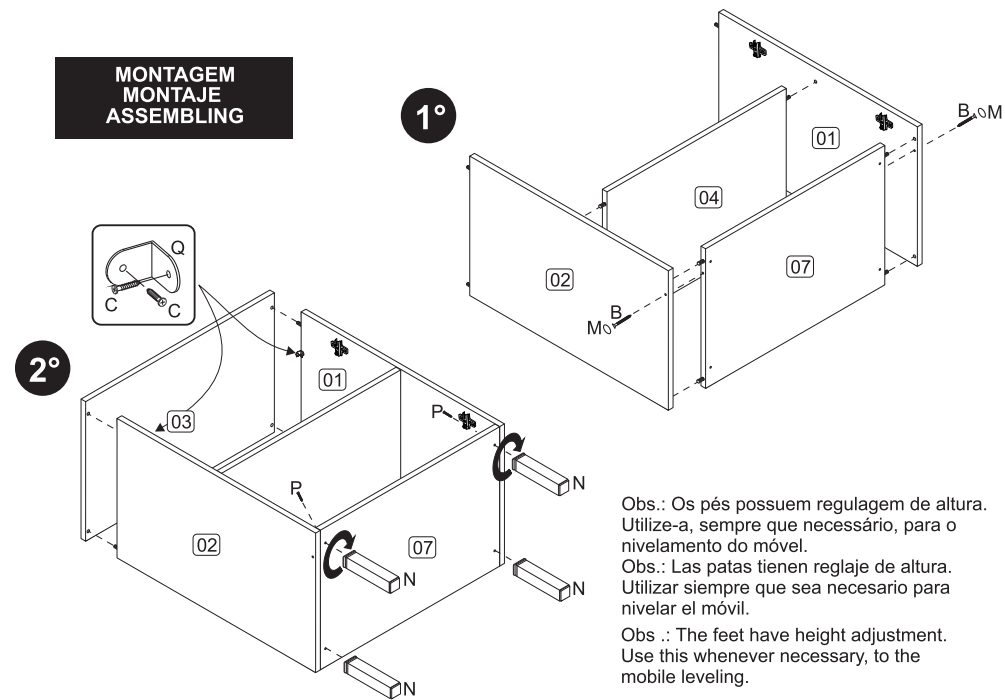

Obs.: Os pés possuem regulagem de altura. Utilize-a, sempre que necessário, para o nivelamento do móvel.
Obs.: Las patas tienen reglaje de altura. Utilizar siempre que sea necesario para nivelar el móvil.
Obs.: The feet have height adjustment. Use this whenever necessary, to the mobile leveling.

Atenção!!!

1) Para unir este módulo a outro usar os 2 parafusos (H) e 2 Tapa-furos (M).

Atención!!!

1) Para unirse un módulo a otro usar 2 tornillos (H) y 2 tapa agujero (M).

Attention!!!

1) To join this module to use the other two screws (H) and two hides holes (M).

3°

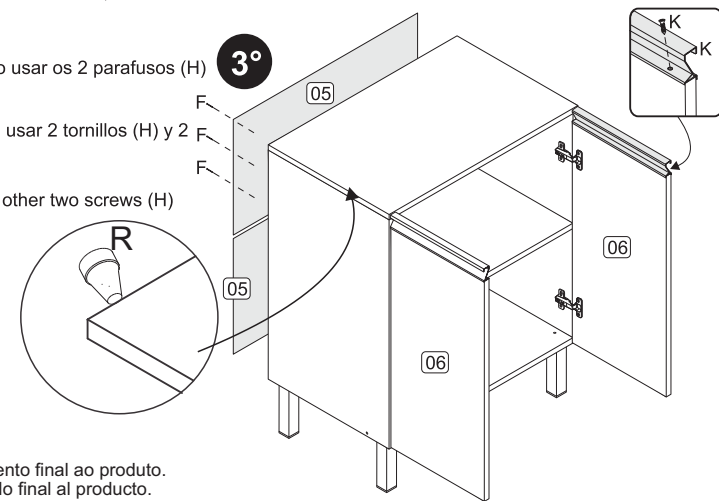

Utilize o giz para dar o acabamento final ao produto.
Utilice la tiza para dar el acabado final al producto.
Use the chalk to give the final finish on the product.

Garantia (exclusivo para o Brasil/exclusivo de Brasil/exclusive to Brazil):
A garantia dos produtos fabricados pela BRV Móveis, abrange eventuais defeitos-vícios de fabricação, no prazo estabelecido pelo Código de Defesa do Consumidor, em seu artigo 26,II, o qual prevê a garantia legal de 90 (noventa) dias.

